

Referência: 3090
 Linha: Cilíndrico
 Categoria: Pendente
 Descrição: Pendente Cilíndrico REF 3090
 Dimensões:
 • Altura: 15cm
 • Profundidade: 10cm
 • Diâmetro: 90cm



Peso: 6.200g
 Material: Lâmina natural de madeira, MDF, Acrílico, Cabos de aço







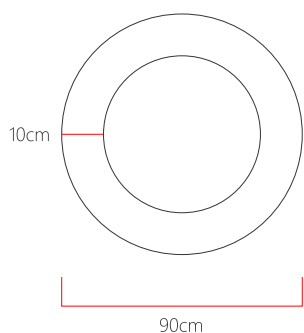
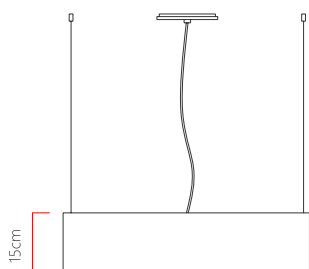

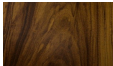

Soquete: E27 9x (25W max. cada) Fluorescente ou LED lâmpadas não inclusa
 Temperatura de Cor: De acordo com a lâmpada
 CRI: De acordo com a lâmpada
 Fluxo Luminoso: De acordo com a lâmpada
 Lumens Entregue: De acordo com a lâmpada
 Potência Total: De acordo com a lâmpada

Tensão de Entrada: 110V - 220V
 Frequência de Entrada: 60 Hz
 Isolamento: Classe II
 Proibido o uso de lâmpadas incandescente

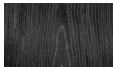
Cabos de sustentação padrão 200cm (outras medidas consulte-nos)



Opções de acabamentos

	01 Madeira Imbuia		02 Madeira Freijo
	03 Madeira Nogueira		04 Madeira Teca
	05 Madeira Pinus		06 Madeira Ébano
	07 Madeira Ébano Macassar		08 Madeira Platinum
	09 Madeira Rovere		10 Madeira Nogueira Linheira
	11 Madeira Cinamomo		12 Madeira Pau Ferro